

TRENCH SHEETING & SHEET PILE



SHORE HIRE STOCK A RANGE OF TRENCH SHEETS & SHEET PILE USED FOR TEMPORARY APPLICATIONS.

Our range of Trench Sheets & Sheet Pile can be used in various applications, such as closing off ends of trench boxes to large perimeter sheet shoring systems. Shore Hire has three types of Trench Sheets available; the SHS-330, SHS-400, and SHS-600. The SHS-330 is a light-duty Trench Sheet that can be easily handled, whereas the SHS-400 and SHS-600 are used for larger excavations and are available in longer lengths. We also stock GU 13N in Sheet Pile. Accessories such as driving caps, sheet extractors, and excavator mounted vibrators (EMV) are available to make your installation and removal as hassle-free as possible.



FEATURES

- Can be used with our Timber Walers, Hydraulic Walers, and Hydraulic Bracing Systems
- Can be used as end shoring in Trench Boxes
- Half clutch at one end for easy sheet guidance when installing
- Various lengths in stock to suit a variety of applications
- Full range of handling and driving accessories available
- Engineered Trench Sheet solutions are available

TRENCH SHEETING & SHEET PILE

SHS-330 DIMENSIONS

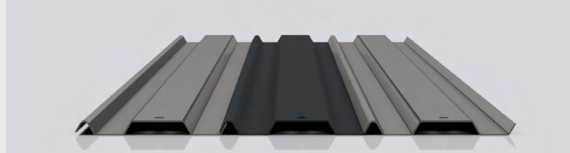
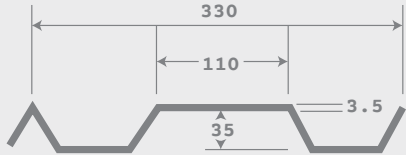

SHS-400 DIMENSIONS

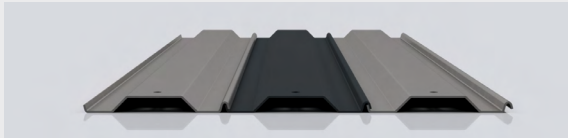
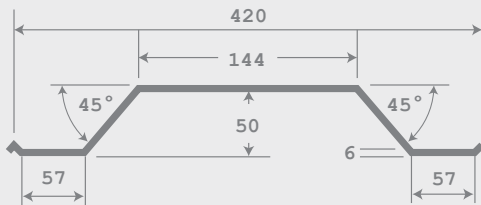

SHS-600 DIMENSIONS

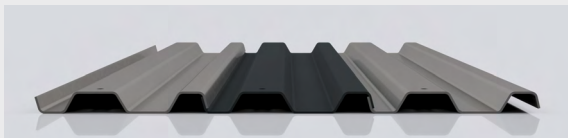
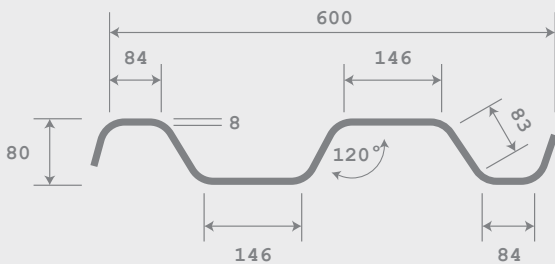

TRENCH SHEETING SPECIFICATIONS

Specifications	SHS-330	SHS-400	SHS-600
Steel Thickness	3.5mm	6mm	8mm
Standard Lengths	3-5m	2-5.8m	3-5.8m
Weight Per Linear Metre	11.3kg	22.1kg	50kg
Weight Per Square Metre	34.4kg	55.3kg	83.3kg
Section Modulus Per Metre	45.7cm ³	98.8cm ³	242cm ³
Bending Moment Per Linear Metre	7.5kNm	16.3kNm	39.9kNm
Moment of Inertia Per Metre	84.8cm ⁴	250cm ⁴	947cm ⁴
Sheet Width	350mm	420mm	620mm
Coverage	330mm	400mm	600mm
Depth of Section	35mm	50mm	80mm

Note: Specifications are approximate.

TRENCH SHEETING & SHEET PILE

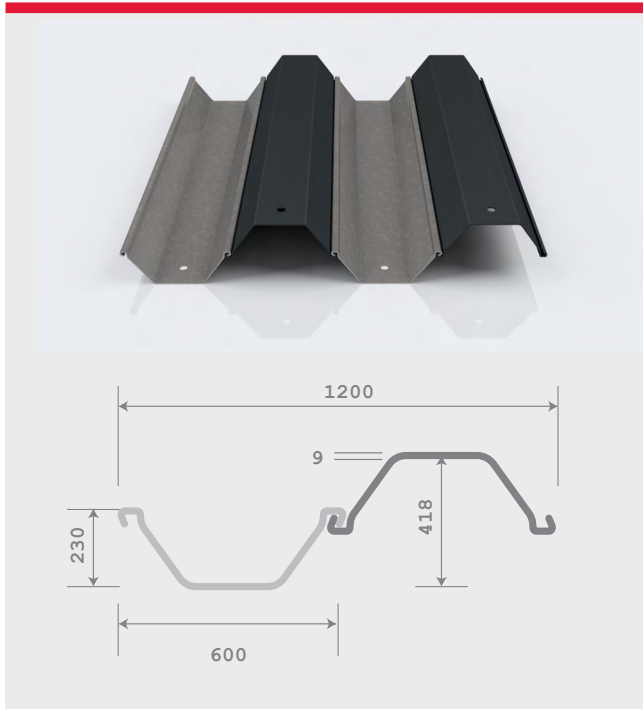

SHEET PILE SPECIFICATIONS		
	GU 13N	GU 16N
Width	600mm	600mm
Length	8m	6m, 9m
Sheet Height	230mm	215mm
Height When Clutched	418mm	430mm
Thickness	9mm	10.2mm
Weight Per Linear Metre	59.9kg/m	72.6kg/m
Weight Per Square Metre	99.8kg/m ²	121.0kg/m ²
Moment Of Inertia	26590cm ⁴ /m	35950cm ⁴ /m
Elastic Section Modulus	1270cm ³ /m	1670cm ³ /m
Plastic Section Modulus	1535cm ³ /m	1988cm ³ /m
Material Grade	S275 GP	S390 GP

TRENCH SHEETING & SHEET PILE ACCESSORIES



Sheet Handler

SHEET HANDLER

- Designed to place and extract trench sheets and sheet piles
- Pin release from ground level
- 20kg



Sheet Extractor

SHEET EXTRACTOR

- Designed for safe extraction of trench sheets and sheet piles
- Fitted with certified D shackles for attachment to appropriate lifting chain
- Secondary safety clip to prevent the release of sheet
- 14.6kg



Driving Cap

DRIVING CAPS

- Improved driveability
- Reduces end damage to sheets/piles
- 15.9kg

EXCAVATOR MOUNTED VIBRATOR (EMV)



THE SHORE HIRE HYDRAULIC EXCAVATOR MOUNTED VIBRATOR.

When the Shore Hire Hydraulic Excavator Mounted Vibrator (EMV) is installed on an excavator, it can drive and extract trench sheets, sheet piles, H Beams, casings, and piles for shoring for all types of trenches, bore pits, pump stations, and perimeter excavations.

The advantages of the EMV are its small size which improves the workability in small spaces, has a minimum effect on the environment and surrounding structures, and creates low noise pollution. It's designed for easy installation onto excavators, and Shore Hire has quick hitch couplers to suit most machines from 12 - 40t.

*Swan neck attachment to increase reach of machine also available for hire

QUICK HITCH



EMV300

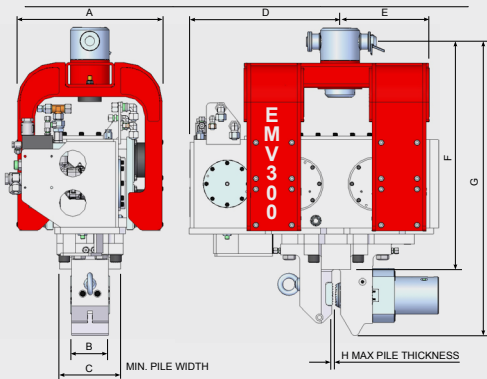

EMV450

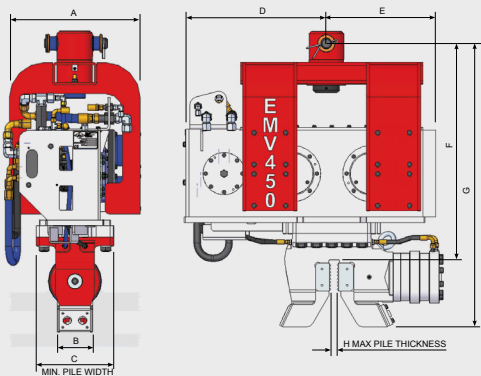

EMV SPECIFICATIONS

Units	EMV 300	EMV 450	EMV 550
Static Moment	4.6kg	6.9kg	8.23kgm
Frequency	2400 r.p.m	2460 r.p.m	2500 r.p.m
Centrifugal Force	300kN	450kN	564kN
Amplitude	14.7mm	12mm	13.7mm
Min Hydraulic Flow Rate	130L/min	195L/min	256L/m
Max Hydraulic Flow Rate	250L/min	350L/min	400L/m
Max Hydraulic Pressure	350bar	350bar	350bar
Min Hydraulic Power	52kW	88kW	120kW
Dynamic Mass	625kg	1008kg	1150kg
Total Mass	860kg	1275kg	1500kg
Max Pile Mass	800kg	1000kg	1400kg
Max Push/Pull Force	15000kg	15000kg	22500kg
Clamp Force	54t	54t	66t
Dimension A	615mm	615mm	646mm
Dimension B	150mm	175mm	190mm
Dimension C	250mm	230mm	370mm
Dimension D	582mm	640mm	708mm
Dimension E	429mm	510mm	555mm
Dimension F	927mm	945mm	1137mm
Dimension G	1200mm	1250mm	1477mm
Dimension H	25mm	32mm	50mm
Machine Size	12-35t	20-45t	30-55t

Note: Specifications are approximate.

SHORE BRACE 200 HYDRAULIC BRACING

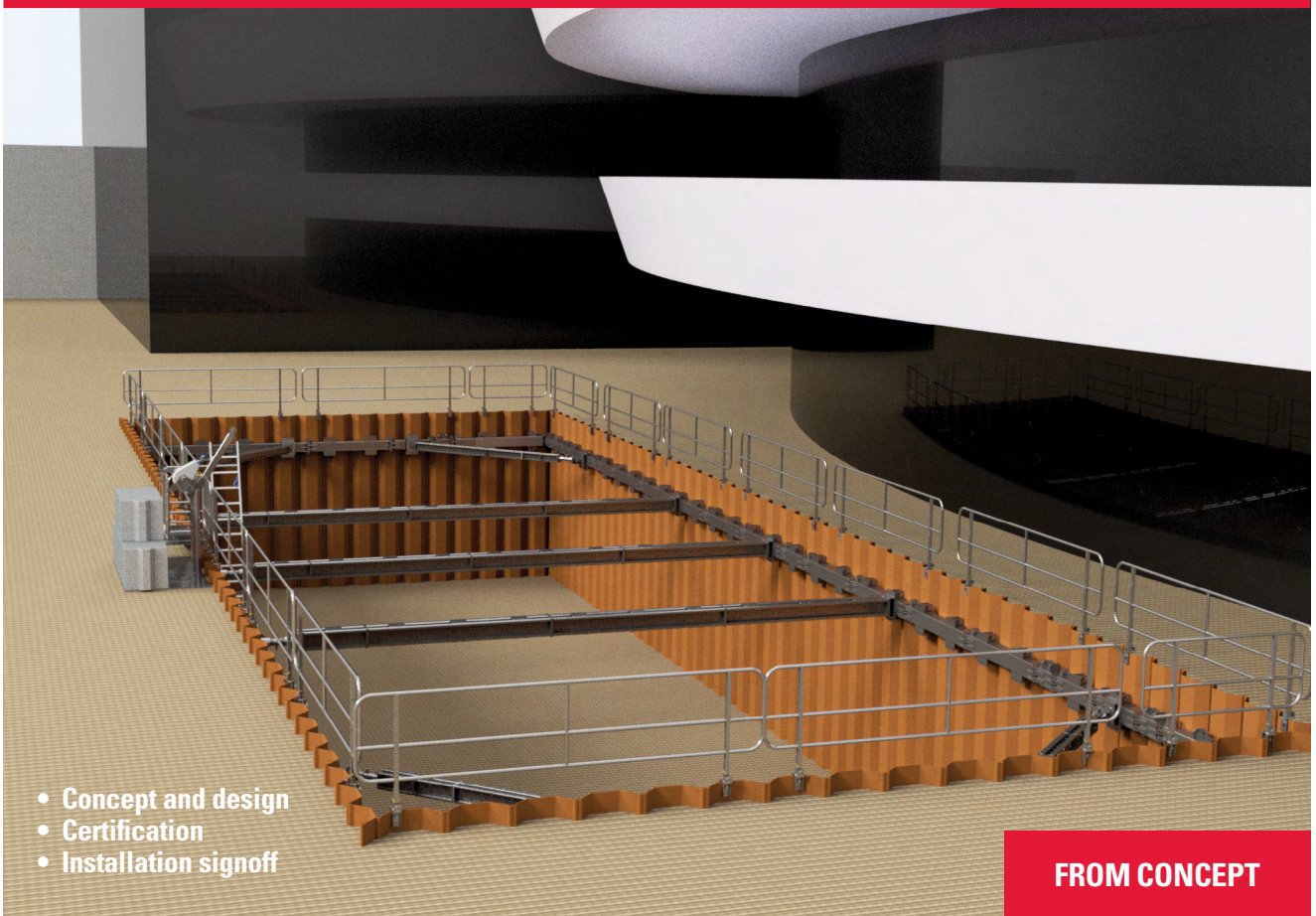

SHORE BRACE 200 HYDRAULIC BRACING

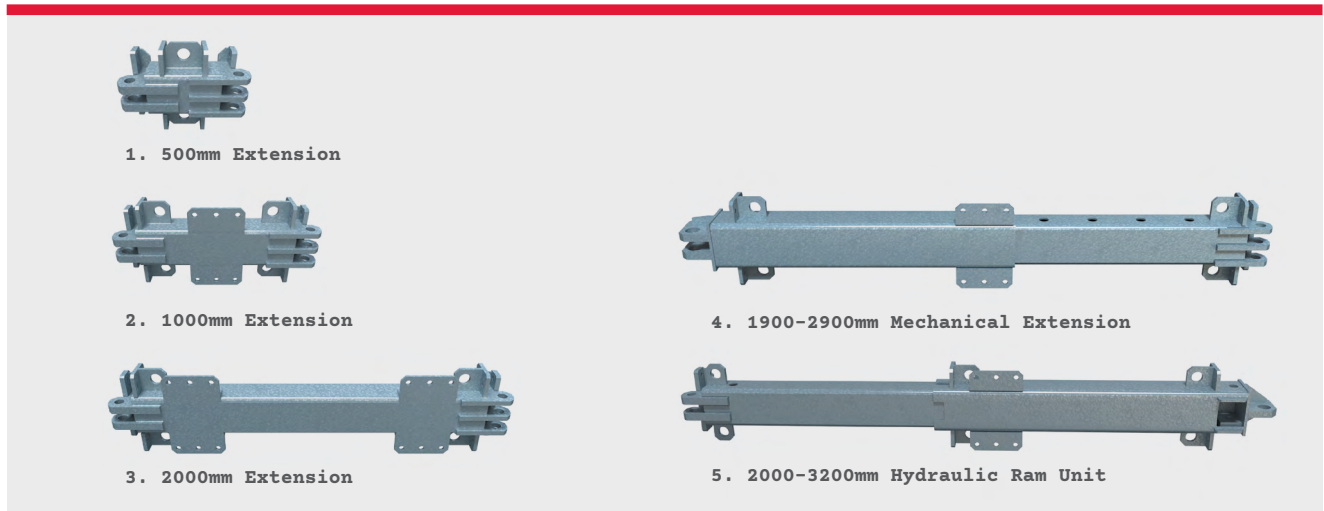

SHORE BRACE 200 HYDRAULIC BRACE AND MECHANICAL SYSTEM

The Shore Brace 200 Brace System contains fixed and mechanical extensions used in conjunction with the hydraulic ram unit to achieve positive pressure for large 4-sided excavations.

It is particularly suited to larger excavations. Shore Hire's Shore Brace 200 Hydraulic Bracing System is an extremely flexible, strong, durable, modular hydraulic bracing frame that can be configured to satisfy multi-sided excavations in conjunction with trench sheets for perimeter support. Typical applications include large tank installation, interceptor chambers, pump stations, stormwater pits, gross pollutant traps, boring pits, and lift wells.

FEATURES

- Engineered Hydraulic Brace System design available by Shore Hire Engineering
- Hydraulic lock-off valves for maximum control and safety
- Double-acting hydraulics can be pumped both in and out for improved operation and simplicity
- Single composite legs have a simple corner pin connection for speed and ease of assembly, installation, and extraction
- Various sizes can be combined to meet a range of excavation applications
- Cross and corner brace are available

HANGING CHAINS

- Range of restraining or hanging chains for vertical support of Waler and Brace Systems
- Certified and compliant with Australian Standards
- Required for support of equipment during installation, removal, or in the event of a system failure
- Can not be used for lifting or extracting

SHORE BRACE 200 SPECIFICATIONS

#	Description	Length (mm)	Section (mm)	Weight (kg)
1	500mm Extension	500	220 x 200	138
2	1000mm Extension	1000	220 x 200	179
3	2000mm Extension	2000	220 x 200	277
4	Mechanical Extension	1900-2900	240 x 215	285
5	Hydraulic Ram Unit	2000-3200	240 x 215	420

Note: Specifications are approximate.

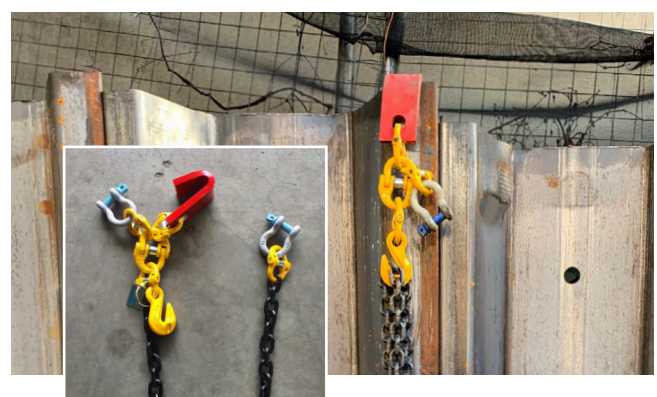

SHORE BRACE 400 HYDRAULIC BRACING



HYDRAULIC SHORE BRACE 400 SYSTEM

The Shore Brace Hydraulic Brace is a modular system comprising of various sized extension beams that are double-pinned and connected to a high-load capacity Hydraulic Ram.

With further engineering design and adding the high-load Shore Brace 400 Hydraulic Cross Brace or corner brace, much larger and more complex perimeter support projects can be safely shored using additional frames to increase the system's capacity.

Our in-house engineering team designs the Shore Brace 400 Hydraulic System. For maximum safety and compliance, a 24-hour/7 day full monitoring system is available, can be accessed remotely, and set up to notify of any movement outside of pre-determined parameters.

FEATURES

- Certified Hydraulic Brace System designed by our engineering team
- Load monitoring system for maximum safety
- Composite legs that have a simple corner pin
- Connection for speed and ease of assembly, installation, and extraction

- Double-acting hydraulics can be pumped both in and out for improved operation and simplicity
- Various sizes can be combined to meet a range of excavation applications
- Cross brace, corner brace, and raking systems are available
- Double pinned joint for maximum load capacity
- Hydraulic lock-off valves for maximum control and safety
- Motorised hydraulic pump for easy adjustment of ram

SHORE BRACE 400 SPECIFICATIONS

#	Description	Length (mm)	Section (mm)	Weight (kg)
1	500mm Extension	500	UC 356 x 368	420
2	1000mm Extension	1000	UC 356 x 368	600
3	2000mm Extension	2000	UC 356 x 368	835
4	4000mm Extension	4000	UC 356 x 368	1275
5	6000mm Extension	6000	UC 356 x 368	1705
6	8000mm Extension	8000	UC 356 x 368	2135
7	Shore Brace Ram Unit	2150–3150	SHS 400 x 400	1415

SHORE BRACE 400 HYDRAULIC BRACING



6. 8000mm Extension



1. 500mm Extension



5. 6000mm Extension

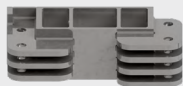

2. 1000mm Extension



4. 4000mm Extension



3. 2000mm Extension



7. 2150mm to 3150mm RAM

SHORE STRUT 400



Shore Hire have also recently developed the Shore Strut 400, which is a 1250kN Hydraulic Strut designed to be used in conjunction with the Shore Brace 400 system to eliminate the need for multiple cross struts in larger excavations.

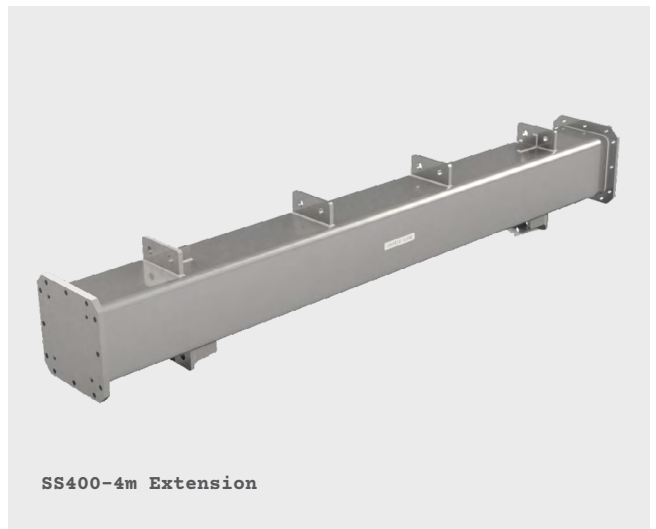

SHORE STRUT 400

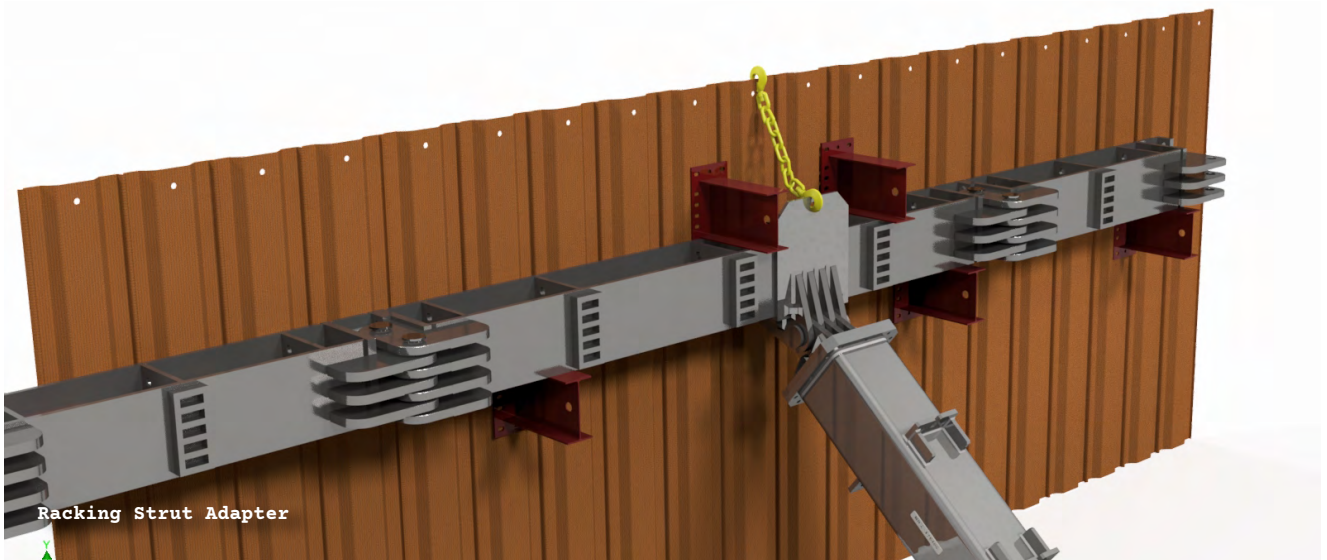
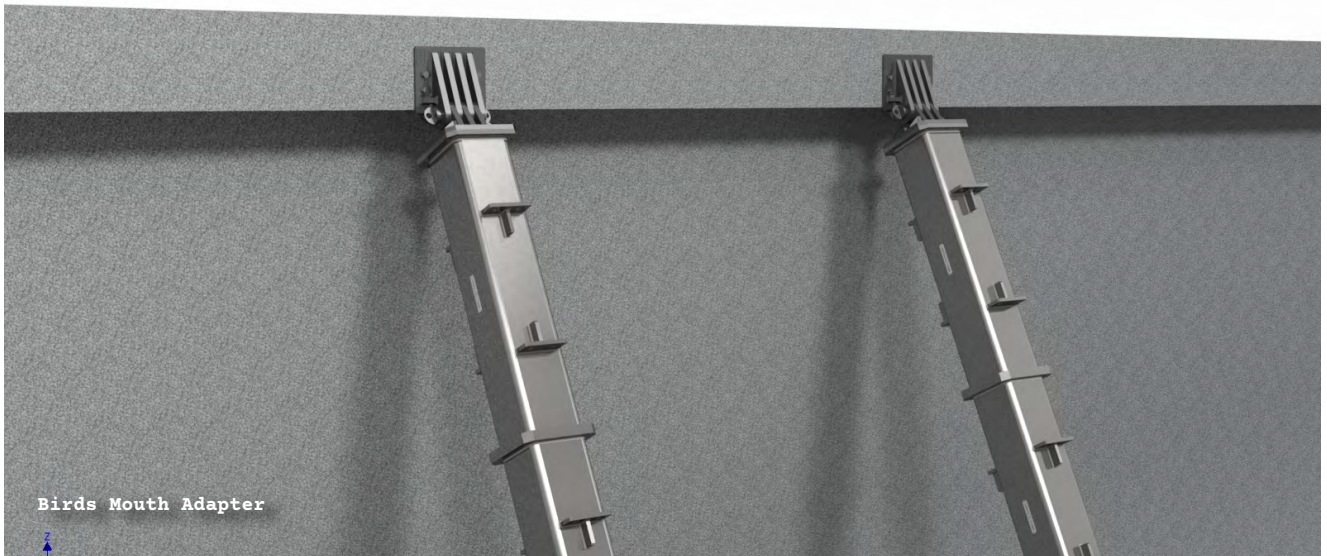

SHORE BRACE 400 ACCESSORIES

